

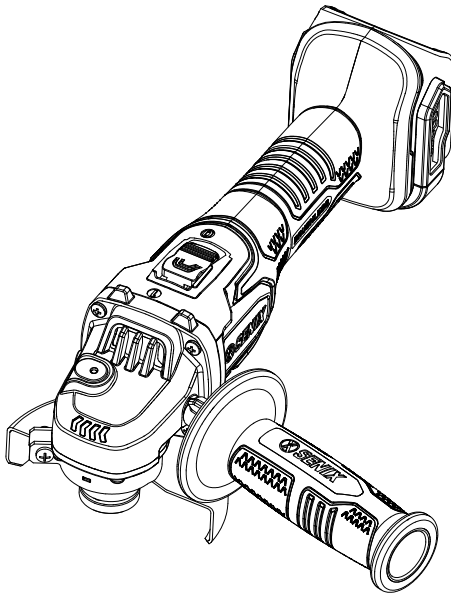

BRUSHLESS ANGLE GRINDER



- SAFETY
- ASSEMBLY
- OPERATION
- MAINTENANCE
- WARRANTY

CAUTION: Before using this tool, please read this manual completely, and follow all operating safety measures.

For customer service please find all information on www.senixtools.com
CAUTION: BEFORE USING THIS PRODUCT, READ THIS MANUAL AND FOLLOW ALL ITS SAFETY RULES AND OPERATING INSTRUCTIONS.

ORIGINAL INSTRUCTIONS

TABLE OF CONTENTS

SAFETY & INTERNATIONAL SYMBOLS	2
SAFETY INSTRUCTIONS.....	3
KNOW YOUR UNIT.....	11
SPECIFICATIONS.....	12
ASSEMBLY.....	13
OPERATION.....	15
MAINTENANCE.....	18
TROUBLESHOOTING.....	20

SAFETY & INTERNATIONAL SYMBOLS

Explanation of Safety & international symbols describes safety and international symbols and pictographs that may appear on this product. Read the operator's manual for complete safety, assembly, operating and maintenance and repair information.



Caution / Warning.

battery to microwaves or high pressures.



To reduce the risk of injury, user must read instruction manual.



Keep bystanders a safe distance away from the work area.



Wear eye protection.



Indoor use only. Only use battery charger indoors.



Wear a dust mask.



Wear safety footwear.



Single mark of circulation of products on the market of the Member States of the Customs Union.



Wear protective gloves.



Waste electrical products should not be disposed of with household waste. Please recycle where facilities exist. Check with your Local Authority or local store for recycling advice.



Do not dispose of battery packs in rivers or immerse in water.



Do not dispose of battery packs in fire. They will explode and cause injury.



Crossed out dust bin. Batteries and battery packs should not be disposed of with household waste. Please recycle where facilities exist. Check with your Local Authority or local store for recycling advice.



Use and store the battery within an temperature below 50°C.



Do not disassemble, crush, heat above 100°C; Never expose the

SAFETY INSTRUCTIONS

GENERAL POWER TOOL SAFETY WARNINGS

WARNING!

Read all safety warnings, instructions, illustrations and specifications, provided with this power tool. Failure to follow all instructions listed below may result in electric shock, fire and/or serious injury.

Save all warnings and instructions for future reference.

The term "power tool" in the warnings refers to your mains-operated (corded) power tool or battery-operated (cordless) power tool.

1) Work Area Safety

- a) **Keep work area clean and well lit. Cluttered or dark areas invite accidents.**
- b) **Do not operate power tools in explosive atmospheres, such as in the presence of flammable liquids, gases or dust.** Power tools create sparks which may ignite the dust or fumes.
- c) **Keep children and bystanders away while operating a power tool.** Distractions can cause you to lose control.

2) Electrical Safety

- a) **Power tool plugs must match the outlet. Never modify the plug in any way. Do not use any adapter plugs with earthed (grounded) power tools.** Unmodified plugs and matching outlets will reduce risk of electric

shock.

- b) **Avoid body contact with earthed or grounded surfaces, such as pipes, radiators, ranges and refrigerators.** *There is an increased risk of electric shock if your body is earthed or grounded.*
- c) **Do not expose power tools to rain or wet conditions.** *Water entering a power tool will increase the risk of electric shock.*
- d) **Do not abuse the cord. Never use the cord for carrying, pulling or unplugging the power tool.** *Keep cord away from heat, oil, sharp edges or moving parts. Damaged or entangled cords increase the risk of electric shock.*
- e) **When operating a power tool outdoors, use an extension cord suitable for outdoor use.** *Use of a cord suitable for outdoor use reduces the risk of electric shock.*
- f) **If operating a power tool in a damp location is unavoidable, use a residual current device (RCD) protected supply.** *Use of an RCD reduces the risk of electric shock.*

3) Personal Safety

- a) **Stay alert, watch what you are doing and use common sense when operating a power tool. Do not use a power tool while you are tired or under the influence of drugs, alcohol or medication.** *A moment of inattention while operating power tools may result in serious personal injury.*

- b) **Use personal protective equipment. Always wear eye protection.** *Protective equipment such as a dust mask, non-skid safety shoes, hard hat or hearing protection used for appropriate conditions will reduce personal injuries.*
- c) **Prevent unintentional starting. Ensure the switch is in the off-position before connecting to power source and/or battery pack, picking up or carrying the tool.** *Carrying power tools with your finger on the switch or energising power tools that have the switch on invites accidents.*
- d) **Remove any adjusting key or wrench before turning the power tool on.** *A wrench or a key left attached to a rotating part of the power tool may result in personal injury.*
- e) **Do not overreach. Keep proper footing and balance at all times.** *This enables better control of the power tool in unexpected situations.*
- f) **Dress properly. Do not wear loose clothing or jewellery. Keep your hair and clothing away from moving parts.** *Loose clothes, jewellery or long hair can be caught in moving parts.*
- g) **If devices are provided for the connection of dust extraction and collection facilities, ensure these are connected and properly used.** *Use of dust collection can reduce dust-related hazards.*
- h) **Do not let familiarity gained from frequent use of tools allow you to become**

complacent and ignore tool safety principles. *A careless action can cause severe injury within a fraction of a second.*

4) Power Tool Use And Care

- a) **Do not force the power tool. Use the correct power tool for your application.** *The correct power tool will do the job better and safer at the rate for which it was designed.*
- b) **Do not use the power tool if the switch does not turn it on and off.** *Any power tool that cannot be controlled with the switch is dangerous and must be repaired.*
- c) **Disconnect the plug from the power source and/or remove the battery pack, if detachable, from the power tool before making any adjustments, changing accessories, or storing power tools.** *Such preventive safety measures reduce the risk of starting the power tool accidentally.*
- d) **Store idle power tools out of the reach of children and do not allow persons unfamiliar with the power tool or these instructions to operate the power tool.** *Power tools are dangerous in the hands of untrained users.*
- e) **Maintain power tools and accessories.** *Check for misalignment or binding of moving parts, breakage of parts and any other condition that may affect the power tool's operation. If damaged, have the power tool repaired before use. Many accidents are caused by poorly*

- maintained power tools.*
- f) **Keep cutting tools sharp and clean.** *Properly maintained cutting tools with sharp cutting edges are less likely to bind and are easier to control.*
 - g) **Use the power tool, accessories and tool bits etc. in accordance with these instructions, taking into account the working conditions and the work to be performed.** *Use of the power tool for operations different from those intended could result in a hazardous situation.*
 - h) **Keep handles and grasping surfaces dry, clean and free from oil and grease.** *Slippery handles and grasping surfaces do not allow for safe handling and control of the tool in unexpected situations.*

5) Battery Tool Use And Care

- a) **Recharge only with the charger specified by the manufacturer.** *A charger that is suitable for one type of battery pack may create a risk of fire when used with another battery pack.*
- b) **Use power tools only with specifically designated battery packs.** *Use of any other battery packs may create a risk of injury and fire.*
- c) **When battery pack is not in use, keep it away from other metal objects, like paper clips, coins, keys, nails, screws or other small metal objects, that can make a connection from one terminal to another.** *Shorting the battery terminals*

together may cause burns or a fire.

- d) **Under abusive conditions, liquid may be ejected from the battery; avoid contact. If contact accidentally occurs, flush with water. If liquid contacts eyes, additionally seek medical help.** *Liquid ejected from the battery may cause irritation or burns.*
- e) **Do not use a battery pack or tool that is damaged or modified.** *Damaged or modified batteries may exhibit unpredictable behaviour resulting in fire, explosion or risk of injury.*
- f) **Do not expose a battery pack or tool to fire or excessive temperature.** *Exposure to fire or temperature above 130 °C may cause explosion.*
- g) **Follow all charging instructions and do not charge the battery pack or tool outside the temperature range specified in the instructions.** *Charging improperly or at temperatures outside the specified range may damage the battery and increase the risk of fire.*

6) Service

- a) **Have your power tool serviced by a qualified repair person using only identical replacement parts.** *This will ensure that the safety of the power tool is maintained.*
- b) **Never service damaged battery packs.** *Service of battery packs should only be performed by the manufacturer or authorized service providers.*

SAFETY WARNINGS COMMON FOR GRINDING OR ABRASIVE CUTTING- OFF OPERATIONS

- a) **This power tool is intended to function as a grinder or cut-off tool. Read all safety warnings, instructions, illustrations and specifications provided with this power tool.** *Failure to follow all instructions listed below may result in electric shock, fire and/or serious injury.*
- b) **Operations such as sanding, wire brushing, polishing are not recommended to be performed with this power tool.** *Operations for which the power tool was not designed may create a hazard and cause personal injury.*
- c) **Do not use accessories which are not specifically designed and recommended by the tool manufacturer.** *Just because the accessory can be attached to your power tool, it does not assure safe operation.*
- d) **The rated speed of the accessory must be at least equal to the maximum speed marked on the power tool.** *Accessories running faster than their rated speed can break and fly apart.*
- e) **The outside diameter and the thickness of your accessory must be within the capacity rating of your power tool.** *Incorrectly sized accessories cannot be adequately guarded or controlled.*
- f) **Threaded mounting of accessories must match the grinder spindle thread. For accessories mounted by flanges, the arbour hole of the accessory must fit the locating diameter of the flange.** *Accessories that do not match the mounting hardware of the power tool will run out of balance, vibrate excessively and may cause loss of control.*
- g) **Do not use a damaged accessory. Before each use inspect the accessory such as abrasive wheels for chips and cracks, backing pad for cracks, tear or excess wear, wire brush for loose or cracked wires. If power tool or accessory is dropped, inspect for damage or install an undamaged accessory. After inspecting and installing an accessory, position yourself and bystanders away from the plane of the rotating accessory and run the power tool at maximum no-load speed for one minute.** *Damaged accessories will normally break apart during this test time.*
- h) **Wear personal protective equipment. Depending on application, use face shield, safety goggles or safety glasses. As appropriate, wear dust mask, hearing protectors, gloves and workshop apron capable of stopping small abrasive or workpiece fragments. The eye protection must be capable of stopping flying debris generated by various operations.** *The dust mask or respirator must be*

capable of filtrating particles generated by your operation. Prolonged exposure to high intensity noise may cause hearing loss.

- i) **Keep bystanders a safe distance away from work area. Anyone entering the work area must wear personal protective equipment.** *Fragments of workpiece or of a broken accessory may fly away and cause injury beyond immediate area of operation.*
- j) **Hold the power tool by insulated gripping surfaces only, when performing an operation where the cutting tool may contact hidden wiring.** *Contact with a "live" wire will also make exposed metal parts of the power tool "live" and could give the operator an electric shock.*
- k) **Position the cord clear of the spinning accessory.** *If you lose control, the cord may be cut or snagged and your hand or arm may be pulled into the spinning accessory.*
- l) **Never lay the power tool down until the accessory has come to a complete stop.** *The spinning accessory may grab the surface and pull the power tool out of your control.*
- m) **Do not run the power tool while carrying it at your side.** *Accidental contact with the spinning accessory could snag your clothing, pulling the accessory into your body.*
- n) **Regularly clean the power tool's air vents.** *The motor's fan will draw the dust inside*

the housing and excessive accumulation of powdered metal may cause electrical hazards.

- o) **Do not operate the power tool near flammable materials.** *Sparks could ignite these materials.*
- p) **Do not use accessories that require liquid coolants.** *Using water or other liquid coolants may result in electrocution or shock.*

KICKBACK AND RELATED WARNINGS

Kickback is a sudden reaction to a pinched or snagged rotating wheel, backing pad, brush or any other accessory. Pinching or snagging causes rapid stalling of the rotating accessory which in turn causes the uncontrolled power tool to be forced in the direction opposite of the accessory's rotation at the point of the binding.

For example, if an abrasive wheel is snagged or pinched by the workpiece, the edge of the wheel that is entering into the pinch point can dig into the surface of the material causing the wheel to climb out or kick out. The wheel may either jump toward or away from the operator, depending on direction of the wheel's movement at the point of pinching.

Abrasive wheels may also break under these conditions. Kickback is the result of power tool misuse and/or incorrect operating procedures or conditions and can be avoided by taking proper precautions as given below.

- a) **Maintain a firm grip on the power tool and position your**

body and arm to allow you to resist kickback forces. Always use auxiliary handle, if provided, for maximum control over kickback or torque reaction during start-up. *The operator can control torque reactions or kickback forces, if proper precautions are taken.*

- b) **Never place your hand near the rotating accessory.** *Accessory may kickback over your hand.*
- c) **Do not position your body in the area where power tool will move if kickback occurs.** *Kickback will propel the tool in direction opposite to the wheel's movement at the point of snagging.*
- d) **Use special care when working corners, sharp edges etc. Avoid bouncing and snagging the accessory.** *Corners, sharp edges or bouncing have a tendency to snag the rotating accessory and cause loss of control or kickback.*
- e) **Do not attach a saw chain woodcarving blade or toothed saw blade.** *Such blades create frequent kickback and loss of control.*

SAFETY WARNINGS SPECIFIC FOR GRINDING AND ABRASIVE CUTTING OFF OPERATIONS

- a) **Use only wheel types that are recommended for your power tool and the specific guard designed for the selected wheel.** *Wheels for which the power tool was not designed cannot be adequately guarded*

and are unsafe.

- b) **The guard must be securely attached to the power tool and positioned for maximum safety, so the least amount of wheel is exposed towards the operator.** *The guard helps to protect the operator from broken wheel fragments, accidental contact with wheel and sparks that could ignite clothing.*
- c) **Wheels must be used only for recommended applications. For example: do not grind with the side of cut-off wheel.** *Abrasive cut-off wheels are intended for peripheral grinding, side forces applied to these wheels may cause them to shatter.*
- d) **Always use undamaged wheel flanges that are of correct size and shape for your selected wheel.** *Proper wheel flanges support the wheel thus reducing the possibility of wheel breakage. Flanges for cut-off wheels may be different from grinding wheel flanges.*
- e) **Do not use worn down wheels from larger power tools.** *Wheel intended for larger power tool is not suitable for the higher speed of a smaller tool and may burst.*

SAFETY WARNING FOR BATTERY PACK AND BATTERY CHARGER

- Recharge only with the charger specified by the manufacturer. A charger that is suitable for one type of battery pack may create a risk of fire when used with another battery pack.

- Use appliances only with specifically designated battery packs. Use of any other battery packs may create a risk of injury and fire.

WARNING!

Use only the following battery:
B20X2/B25X2/B40X2/B50X2.

- When battery pack is not in use, keep it away from other metal objects, like paper clips, coins, keys, nails, screws or other small metal objects, that can make a connection from one terminal to another. Shorting the battery terminals together may cause burns or a fire.
- Under abusive conditions, liquid may be ejected from the battery; avoid contact. If contact accidentally occurs, flush with water. If liquid contacts eyes, additionally seek medical help. Liquid ejected from the battery may cause irritation or burns. (This advice is considered correct for conventional NiMh, NiCd, lead acid and lithium-ion cell types. If this advice is incorrect for a cell design that differs from these, then the correct advice may be substituted.)
- Do not use a battery pack or appliance that is damaged or modified. Damaged or modified batteries may exhibit unpredictable behavior resulting in fire, explosion or risk of injury.
- Do not expose a battery pack or appliance to fire or excessive temperature. Exposure to fire or temperature above 130°C may

cause explosion.

- Follow all charging instructions and do not charge the battery pack or appliance outside of the temperature range specified in the instructions. Charging improperly or at temperatures outside of the specified range may damage the battery and increase the risk of fire.
- Do not modify or attempt to repair the appliance or the battery pack (as applicable) except as indicated in the instructions for use and care.

VIBRATION + NOISE REDUCTION

To reduce the impact of noise and vibration emission, limit the time of operation, use low-vibration and low-noise operating modes as well as wear personal protective equipment. Take the following points into account to minimise the vibration and noise exposure risks.

- Only use the product as intended by its design and these instructions.
- Ensure that the product is in good condition and well maintained.
- Use correct attachments for the product and ensure they are in good condition.
- Keep tight grip on the handles/ grip surface.
- Maintain this product in accordance with these instructions and keep it well lubricated (where appropriate).
- Plan your work schedule to spread any high vibration tool use across a longer period of time.

EMERGENCY

Familiarize yourself with the use of this product by means of this instruction manual. Memorize the safety directions and follow them to the letter. This will help to prevent risks and hazards.

- Always be alert when using this product, so that you can recognize and handle risks early. Fast intervention can prevent serious injury and damage to property.
- Switch off the product and remove the battery pack if there are malfunctions. Have the product checked by a qualified professional and repaired, if necessary, before you operate it again.

INTENDED USE

The angel grinder is intended for grinding or cutting wood-based materials, plastic, metals materials without water. Do not use it for other purposes.

KNOW YOUR UNIT

APPLICATIONS

Model:PAX2-M-EU

As an angle grinder:

Cutting and grinding metal, concrete or tiles.



NOTE:

PAX2-M-EU does not include charger and battery pack.

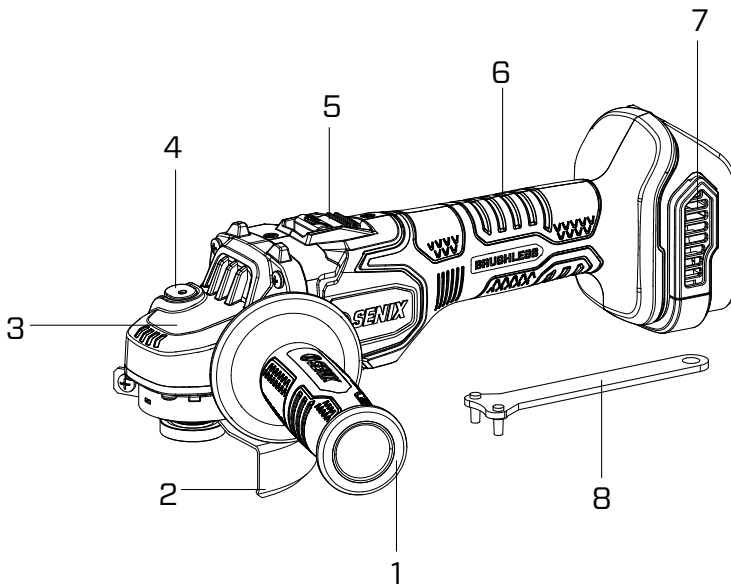

1. Auxiliary Handle
2. Guard
3. Head Shell
4. Spindle Lock

5. On/Off Switch
6. Handle
7. Air Vent
8. Wrench

SPECIFICATIONS

Model	PAX2-M-EU
Rated voltage	18V $\overline{\text{---}}$ (20V Max*)
No load speed	9000/min
Max. disc diameter	100mm
Max. disc thickness	6 mm
Spindle thread	M10
Weight without battery	1.5 kg

ASSEMBLY

1. Unpack all parts and lay them on a flat, stable surface:
2. Remove all packing materials and shipping devices, if applicable.
3. The scope of delivery varies depending on the country and purchased variant:
Model of PAX2-M-EU
 - Angle grinder x1
 - Auxiliary handle x1
 - Guard x1
 - Wrench x1
 - Instruction manual x1
4. If you find that parts are missing or show damage do not use the product but contact your dealer. Using an incomplete or damaged product represents a hazard to people and property.
5. Ensure that you have all the accessories and tools needed for assembly and operation. This also includes suitable personal protective equipment.



NOTE:

PAX2-M-EU does not include charger and battery pack.



WARNING:



Wear protective gloves for this assembly work and always lay the product on a flat and stable surface while assembling.



Follow the assembly instructions step-by-step and use the pictures provided as a visual guide to easily assemble the product! Do not insert the battery pack before the power tool is completely assembled or adjusted!

AUXILIARY HANDLE



WARNING:

Always work with auxiliary handle attached to prevent loss of control and possible serious injury.

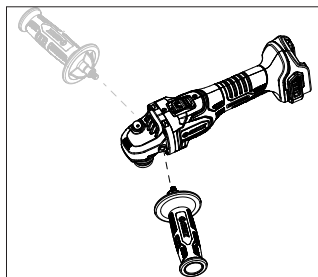

—————Fig. 1 —————

Manually screw the auxiliary handle securely in the left or right threaded hole. Take working requirement or using habit into account for best performance.

GUARD



WARNING:

Attach guard specifically for the work to be performed. The supplied guard is only for grinding.

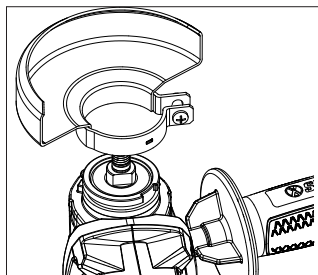

—————Fig. 2 —————

1. Loosen the guard locking screw. Align and seat the guard on the spindle.
2. Turn the guard clockwise to where it always protect user from being hurt.
3. Tighten the guard locking screw.

GRINDING WHEEL



WARNING:

To reduce the risk of injury, use only accessories rated at least equal to the maximum speed marked on the tool.

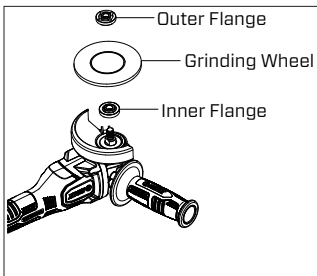

Fig. 3

1. Fit the inner flange on spindle.
2. Lay the grinding wheel flat on the inner flange.
3. Attach the convex side of outer flange to the grinding wheel and secure it with assistance of wrench while pressing the spindle lock.



NOTE:

For cutting, match concave surface to the cutting wheel.

4. Remove wrench and release the

spindle lock when the outer flange get enough tightened.



WARNING:

Never press the spindle lock when the spindle is running.

BATTERY PACK



WARNING:

Make sure the on/off switch is off before mounting the battery pack.

To install:

Align and slide the battery pack to the docking port until it is locked in place.

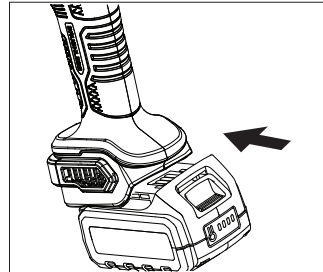

Fig. 4

To remove:

Press the unlock button on battery pack and slide the battery pack out.

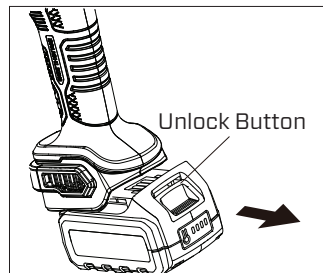

Fig. 5

OPERATION



WARNING:

Always wear eye, hearing, hand protection to reduce the risk of injury when operating the tool. Keep all parts of your body away from the rotating wheel.



WARNING:

Sparks generated when grinding metal. Take care that no combustible materials presented in working area.

SWITCHING ON/OFF



WARNING:

Only start the tool when its wheel is not contacting with workpiece.

1. Turn the on/off switch to "1". The tool will accelerate gradually until it reaches a full speed.
2. Turn the on/off switch to "0". The tool will slow down until it comes to a complete stop.

GENERAL OPERATION

1. Test the machine for a minute at the maximum speed before applying to workpieces.
2. Abandon accessories suffered from a drop before. Out of balance or damaged accessories can mar workpiece, damage the tool, and cause stress that may cause accessory failure.
3. Always guide the grinder with

both hands. Grip the main handle with one hand and another on the auxiliary handle.

4. Use cutting wheel for cutting and use grinding wheel for grinding.
5. Fit a proper guard for the purpose of cutting or grinding to provide maximum protection. Use unsuitable guard during operation will cause serious injury.
6. Secure workpiece in a vise or clamp to a workbench to ensure a safe operation.
7. Allow accessories to come to full speed before start.
8. Properly apply the pressure and control the contact between accessory and workpiece.
9. Lift the grinder away from the workpiece before turning off the grinder.
10. Turn off the tool and make sure it comes to a complete stop before laying it down.

GRINDING

1. Fit a grinding wheel and a guard for grinding recommended by the manufacturer.
2. Position the tool at an angle of 15° to 30° for a best working results.

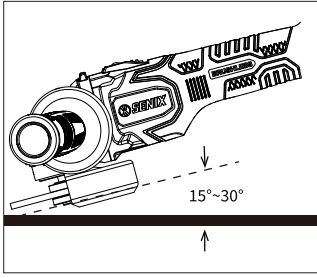

Fig. 6

3. Do not over force the tool. Slightly and evenly press down and lead the machine forward or backward.

CUTTING

1. Replace a cutting wheel and a wheel guard for cutting recommended by manufacturer.
2. Insert the cutting wheel vertically into the surface of objects.
3. Do not give any lateral pressure to the wheel or sway from side to side.
4. Begin cutting with minimum cross-sections.
5. Only work against the run of the wheel.
6. When the wheel become very hot and sparks flash around, stop cutting and cool down at no-load speed for several minutes.

HOW TO CHARGE THE BATTERY PACK



WARNING:

This Lithium-Ion battery pack is shipped partially charged. Fully charge the battery pack before using it for the first time.



NOTE:

Charge batteries at a ambient temperature of 0°C-40°C.

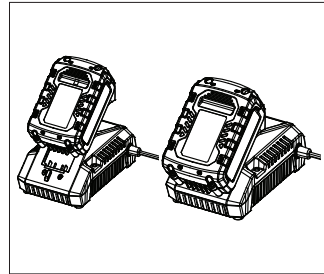
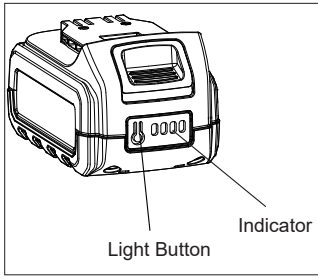

Fig. 7

1. Charge the Lithium-Ion battery pack only with the correct charger.
2. Connect the charger to a power supply, the light indicator of the charger turns red.
3. Align the raised ribs of the battery pack with the slot in the charger.
4. Insert the battery pack into the charger, the light indicator of the charger turns green and it flashes.
5. The charger will communicate with the battery pack to evaluate the condition of the battery pack.
6. It is fully charged that the four lights of the battery turn on. Disconnect the power supply from the charger. Remove battery pack from the charger.

CHARGING INDICATOR

Press the light button on the battery pack to check whether it needs to charge.



In this case, remove the battery from the tool and charge the battery.

Fig. 8

Lights			Remaining Capacity
Lighted	Off	Blinking	
			75% - 100%
			50% - 75%
			25% - 50%
			5% - 25%
			< 5% (need to be charged)



WARNING:

Malfunctions may occur when the four lights blinking in turns.

OVERHEAT PROTECTION

When the tool/battery is overheated, the tool stops automatically. In this situation, let the power tool/battery cool before turning the tool on again.

OVERDISCHARGE PROTECTION

When the battery capacity is not enough, the tool stops automatically.

MAINTENANCE



WARNING:

Only perform cleaning and maintenance work according to these instructions! All further works must be performed by a qualified specialist!



WARNING:

TO PREVENT SERIOUS INJURY FROM ACCIDENTAL OPERATION:
Make sure the on/off switch is turned to "O" and battery pack is removed before performing any procedure in this section.

TO PREVENT SERIOUS INJURY FROM TOOL FAILURE:
Do not use damaged equipments.
If abnormal noise or vibration occurs, have the problem corrected before further use.

There are no user-serviceable parts in your power tool. If any of following condition are found, stop using it and send it to the authorized service center for repair.

- leaking, swollen, or cracked battery pack
- loose hardware
- misalignment or binding of accessories.
- cracked or broken parts.
- any other condition that may affect its safe operation.

CLEANING

1. Clean dust and debris from air vents.

2. Keep handle clean, dry and free of oil or grease.
3. Wipe debris and particles off the wheel.
4. Remove stubborn dirt from housing with high pressure air (max. 3 bar).



NOTE:

Do not use chemical, alkaline, abrasive or other aggressive detergents or disinfectants to clean this product as they might be harmful to its surfaces.

TRANSPORTATION

1. Only carry by its handle.
2. Protect from any heavy impact or strong vibrations which may occur during transportation in vehicles.
3. Secure to prevent it from slipping or falling over.

STORAGE

1. Clean thoroughly as described above.
2. Store in a dark, dry, frost-free and well-ventilated area that is inaccessible to children. The ideal storage temperature is between 50°F(10°C) and 86°F(30°C).
3. Use original package for storage or cover with a suitable cloth to protect it against dust.



NOTE:

To prolong battery life, store the

battery pack separately from the tool in a 30%-50% charged condition. It's recommended to have your battery pack charged at least every 6 months.

DISPOSAL

Waste product should not be disposed of with household waste. Please recycle where facilities exist. Check with your local authority or retailer for recycling advice. Users should clean up the chips generated during operation to protect environment.



Electrical products should not be discarded with household products. Used electrical products must be collected separately and disposed of at collection points provided for this purpose. Talk with your local authorities or dealer for advice on recycling.

TROUBLESHOOTING

Suspected malfunctions are often due to causes that the users can fix themselves. Therefore, check the product using this section. In most cases the problem can be solved quickly.

PROBLEM	POSSIBLE CAUSE	SOLUTION
Product does not start	The power cord is not firmly connected with the power supply	Connect the power cord firmly
	The voltage does not reach the rated voltage	Make sure the voltage reaches the rated voltage
	The motor is damaged	Contact the manufacturer for after-sales service.
Excessive noise	Foreign objects in the motor	Remove foreign objects
	Bearing is damaged	Replace with a new one
	Motor is damaged	Contact the manufacturer for after-sales service
Overheating	Stator coils is overheating	Contact the manufacturer for after-sales service